

Article number: 20343250M1280KSE
Description: E+G Levelling foot
GN 343.2-50-M12-80-KSE
Note: 0

Measures

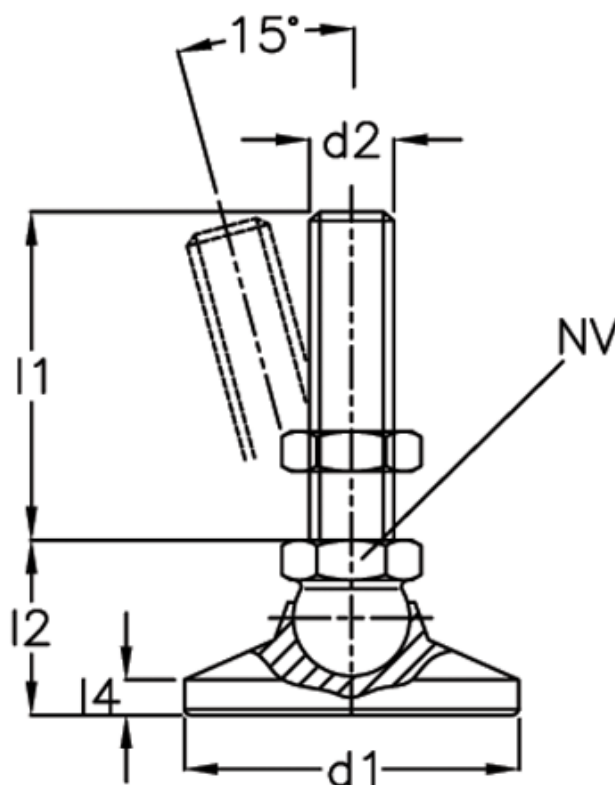

d1 = 50
d2 = M12
l1 = 80
l2 = -
l3 = 29.5
l4 = -
l5 = 8.5
NV = 17

Static load = 33
Weight in (g) = 260